

ISSUE: APRIL 2023

CTSOC-NCT NEWS ON CONSUMER TECHNOLOGY

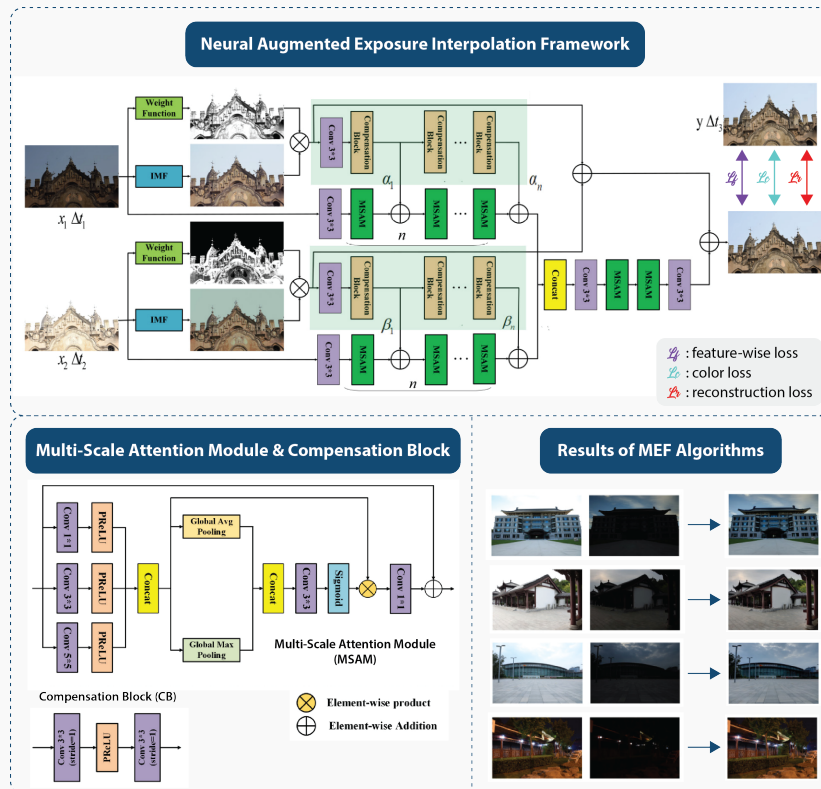

The Proposed Neural Augmented Exposure Interpolation Frameworks with Multi-scale Exposure Fusion (MEF) Algorithm Results

2	EDITOR'S NOTE
3	COVER STORY
4	FEATURED PEOPLE
8	FEATURED ARTICLE

TABLE OF CONTENTS

EDITOR'S NOTE

On behalf of the Editorial Board of IEEE CTSoc News on Consumer Technology (NCT) editor-in-chief Wen-Huang Cheng and editors, Luca Romeo, Chuan-Ju Wang, Jianlong Fu and Loh Yuen Peng, I am happy to introduce the April issue of the NCT in 2023.

This issue starts with a cover story which explained a novel exposure interpolation algorithm fusing model-based and data-driven approaches to form a neural augmented interpolation framework published in the CTSoc's journal, IEEE Transactions on Consumer Electronics. For the proposed method, an image with a medium-exposure is initially interpolated by using intensity mapping functions (IMFs), and then refined via a novel exposedness aware network (EA-Net). It shows that the model-based and data-driven approach can benefit each other for fast convergence speed and learning with few training samples. Moreover, the model-based method can be adopted on the mobile device. Further, the explainability of both the new EA-Net and the proposed framework is improved.

Next, the feature people provide an interview with Dr. Malcolm Doering who is currently a Specially-appointed Assistant Professor at the Human-Robot Interaction (HRI) Laboratory, Kyoto University, Japan. This interview shows his main research topic of imitation learning of social interaction behaviors for robots, and the importance of data-driven imitation learning instead of reinforcement learning for HRI. The interview also talks about the large language models which could benefit robot learning and the research trend in next five years.

Finally, this issue presents a featured article brought by Dr. Takuya Kurihara from the Advanced Telecommunications Research (ATR) Institute International, Japan, discussing on the new application of radio waves in physical sensing. The popularity of Cyber-Physical systems, which aims to optimize real-world information in cyberspace to control physical spaces efficiently, is expected to grow. Therefore, the improved sensors are necessary to capture real-world information. The research on new sensing methods that utilize radio waves is ongoing. This article introduces the current research of ATR on proximity and paper-thin sensors that use radio waves and discusses the future challenges for these sensors.

We hope you can enjoy your reading!

Yafei Hou
Editor of NCT



ARTICLE TITLE

Neural Augmented Exposure Interpolation for Two Large-Exposure-Ratio Images

AUTHOR(S)

Chaobing Zheng , Weibin Jia , Shiqian Wu, and Zhengguo Li

JOURNAL TITLE

IEEE TRASACTIONS ON CONSUMER ELECTRONICS

JOURNAL VOLUME AND ISSUE

Volume: 69, Issue: 1

DATE OF THE ARTICLE

October 2022

PAGE NUMBERS FOR THE ARTICLE

87 - 97

DOI10.1109/TCE.2022.3214382

Brightness order reversal could occur among shadow regions in a bright image and high-light regions in a dark image if two large-exposure-ratio images are fused directly by using existing multi-scale exposure fusion (MEF) algorithms. In other words, the fused image might look unnatural. Thus, exposure interpolation is an effective way to solve this issue. In this paper, a novel exposure interpolation algorithm is introduced by fusing model-based and data-driven approaches to form a neural augmented interpolation framework. An image with a medium-exposure is initially interpolated by using intensity mapping functions (IMFs), and then refined via a novel exposedness aware network (EA-Net). Experimental results show that the model-based approach is improved by the data-driven approach, and the data-driven approach is benefited from the model-based method for fast convergence speed and learning with few training samples. Moreover, the model-based method can be adopted to produce an image for previewing on the mobile device. Further, the explainability of both the new EA-Net and the proposed framework is improved via such a neural augmentation.

INTERVIEW WITH DR. MALCOLM DOERING

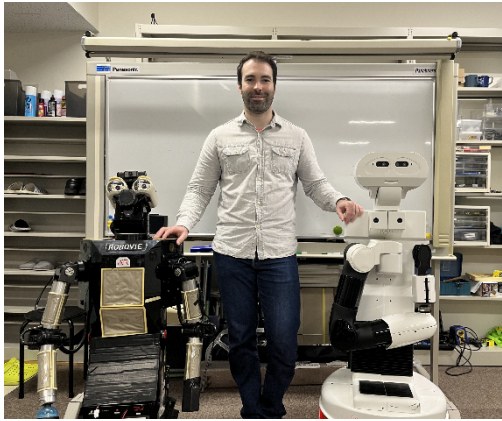

Dr. Malcolm Doering with two of the robots he works with – Robovie (left) and TIAGo (right).

Biography

Dr. Malcolm DOERING is currently a Specially-appointed Assistant Professor at the Human-Robot Interaction Laboratory, Kyoto University, where he is mainly contributing to the JST AIP Trilateral project on Artificial Intelligence for Human-Robot Interaction (AI4HRI). His research focuses on data-driven imitation learning methods for human-robot interaction, i.e., how robots can learn interactive social behaviors automatically from data using machine learning, with minimal input from human designers or expensive manual annotation.

Malcolm is originally from Michigan, USA, where he graduated from Michigan State University in 2015 with an MS in computer science. In 2015 he began working as a research intern at Hiroshi Ishiguro Laboratories, ATR, Kyoto, Japan, where his work with the ERICA android (Fig. 1) won the Best Video Award at HRI 2017 [18]. In 2019 he graduated from Osaka University with a PhD focused on human-robot interaction and joined Prof.

Takayuki Kanda's Human-Robot Interaction Lab at Kyoto University (<https://www.robot.soc.i.kyoto-u.ac.jp/en/>), where he supervises a small team of students. In 2022 he co-organized a workshop on Artificial Intelligence for Social Robots Interacting with Humans in the Real World (intellect4hri) at IROS [19]. He has served on the organizing committee of the HRI 2019 conference and has been a reviewer for many top tier robotics conferences and journals, including ACM/IEEE International Conference on Human-Robot Interaction (HRI), IEEE Robotics and Automation Letters (RA-L), and IEEE/RSJ International Conference on Intelligent Robots and Systems (IROS).

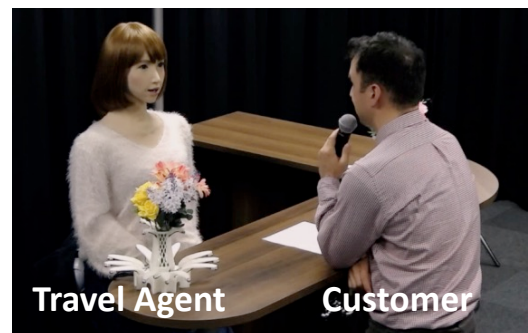

Figure 1. The ERICA android playing the role of a travel agent [12].



Figure 2. Natural human-human interaction data is collected with a passive sensor network and used to train a robot to replace the target human (e.g. a camera shopkeeper) [8,11].

Please briefly introduce you and your team.

Since a young age I have been inspired by science fiction works, like Isaac Asimov's I, Robot and the television program Start Trek, which depict futuristic societies with intelligent robots that are able to communicate fluently with humans. During my early studies I was inspired by these works to explore the fields of computer science and linguistics, where I was further motivated by provocative works like Alan Turing's seminal paper that asked, "Can a machine think?" and suggested that machines might learn to become intelligent, in the way that a child learns [20].

Through my research, I aim to realize socially beneficial robots, like those depicted in sci-fi, towards the goal of improving the human experience and quality of life. On another note, I have also long been interested in Japanese language and culture, such as Zen Buddhism and martial arts. That, combined with the advanced robotics research going on in Japan, led me to where I am today, working at the Human-Robot interaction Lab at Kyoto University, where I research imitation learning of social interaction behaviors and supervise a group of graduate students.

What is the current focus of you and your team's research?

The overall goal of the Human-Robot Interaction Lab is human-robot interaction broadly; but, my students and I are focusing mostly on imitation learning of social

interaction behaviors for robots (Fig. 2).

Recently social robots have been applied in a variety of domains, such as elder care [1], personal companions [2], hotel concierges [3], workout partners [4], and in day-to-day interaction [5], which require various social interaction behaviors. One approach to developing interaction behaviors is to manually code them or use integrated development environments such as choreograph [6] or interaction composer [7], but this is tedious, time-consuming, and requires the developer to anticipate a myriad social scenarios. Another approach, which overcomes these limitations, is to use data-driven imitation learning to learn social interaction behaviors automatically from example interaction data without manual data annotation. With this approach, interaction data can be collected via passive sensor networks in places that people frequently interact and the repeatable, formulaic behaviors, which characterize many domains where social service robots might be useful (e.g. retail, restaurants, and museum tours), can be learned via machine learning with reduced effort by developers.

Our previous work on data-driven imitation learning has focused on one-to-one interactions [8], one-to-many interactions [9], learning proactive behaviors [10], curiosity-driven learning [11], resolving ambiguity [12], remembering customer preferences [13], and adapting to changing product inventory [14].

Currently, we are exploring the application of imitation learning to various problems, including interacting with fellow staff members as well as customers [15], interactive motions (e.g. gestures and body postures, and their relation to the environment) [16], and social interaction behaviors around object manipulation. We are also

exploring how to automatically identify and prevent errors that imitation learning systems make [17].

Why do you choose to focus on data-driven imitation learning instead of reinforcement learning for human-robot interaction?

Reinforcement learning is very hot right now, but imitation learning has some advantages for human-robot interaction.

Reinforcement learning typically requires a lot of trial and error (exploration and exploitation), which is not always appropriate for a robot interacting with humans. Reinforcement learning works well when we can simulate the agent's interaction with the environment, because a large number of training sessions can be simulated very quickly. But, when it comes to social interaction, it is not so simple to design a simulation of a human for the robot to practice interacting with. If we could design such a simulation, the human-robot interaction problem would already largely be solved! Furthermore, it is usually not appropriate to perform RL for social learning in the real world either – people are probably not patient enough to deal with a robot that is frequently making mistakes, causing more trouble than it's worth.

Moreover, RL requires some reward to indicate when the system is performing well. In social interaction, it's not always clear where this reward signal should come from, and whether it can be accurately perceived by the system. For example, consider a tutor robot trying avoid frustrating a student – it would require accurate sensing of the student's facial expression and tone of voice, possibly in noisy environments with various lighting conditions.

In contrast, with imitation learning we can collect datasets of experts performing in some target scenario and use that data to directly train the robot. The robot can learn to perform the same behaviors as the expert without trial and error.

Of course, some combination of reinforcement learning and imitation learning

might be the best for social robots interacting in the real world: Imitation learning can be used to learn a foundation of behaviors and interaction logic on which to build and improve with reinforcement learning during live interactions.

How do you think big models, especially large language models could benefit robot learning?

I believe large language models (LLMs) have a lot of potential for improving robot capabilities. For example, research is already going on about how knowledge embedded in LLMs can be used to teach robots to perform new tasks [21,22]. There is also a lot of knowledge about the unwritten rules of social interaction and social norms implicitly stored in these models. It will be exciting to see in the coming years how this knowledge will be used to enable robots to interact more naturally with humans.

What kinds of directions do you think are most promising in the next 5 years?

Possibly one of the most promising directions will be the application of large language models to robotics and human-robot interaction. To do this though, some problems need to be solved, such as how to ground these models to the robot's sensors and actuators, i.e. how to deal with the 'situatedness' of the robot – its embeddedness in a complex, dynamic environment. Towards solving these problems, it may be good to create large models trained on other data in addition to text. For example, training large predictive models on audio and video data may help to better ground the robot's perception of the environment to the knowledge embedded in the models.

Overall, it is very exciting to be involved in such rapidly evolving field, and I watch with hopeful anticipation of where things will go in the future.

References

- [1] K. Kuwamura, S. Nishio, and H. Ishiguro, *Designing Robots for Positive Communication with Senior Citizens*. Springer, 2016, pp. 955–964.
- [2] H. A. Samani, A. D. Cheok, F. W. Ngiap, A. Nagpal, and M. Qiu, “Towards a formulation of love in human-robot interaction,” in *RO-MAN. IEEE*, 2010, Conference Proceedings, pp. 94–99.
- [3] S. Guo, J. Lenchner, J. H. Connell, M. Dholakia, and H. Muta, “Conversational bootstrapping and other tricks of a concierge robot,” in *HRI, 2017, Conference Proceedings*, pp. 73–81.
- [4] D. J. Rea, S. Schneider, and T. Kanda, ““ is this all you can do? harder!” the effects of (im) polite robot encouragement on exercise effort,” in *Proceedings of the 2021 ACM/IEEE International Conference on Human-Robot Interaction, 2021*, pp. 225–233.
- [5] S. Rosenthal, J. Biswas, and M. Veloso, “An effective personal mobile robot agent through symbiotic human-robot interaction,” in *AAMAS. IFAAMAS, 2010, Conference Proceedings*, pp. 915–922.
- [6] E. Pot, J. Monceaux, R. Gelin, and B. Maisonnier, “Choregraphe: a graphical tool for humanoid robot programming,” in *RO-MAN. IEEE*, 2009, Conference Proceedings, pp. 46–51.
- [7] D. F. Glas, T. Kanda, and H. Ishiguro, “Human-robot interaction design using interaction composer: Eight years of lessons learned,” in *HRI. IEEE Press*, 2016, Conference Proceedings, pp. 303–310.
- [8] P. Liu, D. F. Glas, T. Kanda, and H. Ishiguro, “Data-driven hri: Learning social behaviors by example from human–human interaction,” *IEEE T-RO*, vol. 32, no. 4, pp. 988–1008, 2016.
- [9] A. Nanavati, M. Doering, D. Brščić, and T. Kanda, “Autonomously learning one-to-many social interaction logic from human-human interaction data,” in *Proceedings of the 2020 ACM/IEEE International Conference on Human-Robot Interaction, ser. HRI '20*. New York, NY, USA: Association for Computing Machinery, 2020, p. 419–427. [Online]. Available: <https://doi.org/10.1145/3319502.3374798>
- [10] P. Liu, D. F. Glas, T. Kanda, and H. Ishiguro, “Learning proactive behavior for interactive social robots,” *Autonomous Robots*, vol. 42, no. 5, pp. 1067–1085, 2017.
- [11] M. Doering, P. Liu, D. F. Glas, T. Kanda, D. Kulić, and H. Ishiguro, “Curiosity did not kill the robot: A curiosity-based learning system for a shopkeeper robot,” *ACM Transactions on Human-Robot Interaction (THRI)*, vol. 8, no. 3, p. 15, 2019.
- [12] M. Doering, D. F. Glas, and H. Ishiguro, “Modeling interaction structure for robot imitation learning of human social behavior,” *IEEE Transactions on Human-Machine Systems*, 2019.
- [13] M. Doering, T. Kanda, and H. Ishiguro, “Neural-network-based memory for a social robot: Learning a memory model of human behavior from data,” *J. Hum.-Robot Interact.*, vol. 8, no. 4, Nov. 2019. [Online]. Available: <https://doi.org/10.1145/3338810>
- [14] M. Doering, D. Brščić, and T. Kanda, “Data-driven imitation learning for a shopkeeper robot with periodically changing product information,” *J. Hum.-Robot Interact.*, vol. 10, no. 4, Jul 2021. [Online]. Available: <https://doi.org/10.1145/3451883>
- [15] M. Doering, D. Brščić, T. Kanda. *Learning Social Robot Behaviors for Interacting with Staff and Customers*. Workshop on Machine Learning in Human-Robot Collaboration: Bridging the Gap, 17th ACM/IEEE International Conference on Human-Robot Interaction (HRI 2022), March 2022.
- [16] Y. Jiang, M. Doering, T. Kanda. *Towards Imitation Learning of Human Interactive Motion*. Workshop on Artificial Intelligence for Social Robots Interacting with Humans in the Real World (intellect4hri), 2022 IEEE/RSJ International Conference on Intelligent Robots and Systems (IROS 2022), October 2022.
- [17] J. Ravishankar, M. Doering, T. Kanda. *Analysis of Robot Errors in Social Imitation Learning*. Workshop on Artificial Intelligence for Social Robots Interacting with Humans in the Real World (intellect4hri), 2022 IEEE/RSJ International Conference on Intelligent Robots and Systems (IROS 2022), October 2022.
- [18] Dylan F. Glas, Malcolm Doering, Phoebe Liu, Takayuki Kanda, and Hiroshi Ishiguro. 2017. *Robot's Delight: A Lyrical Exposition on Learning by Imitation from Human-human Interaction*. In *Proceedings of the Companion of the 2017 ACM/IEEE International Conference on Human-Robot Interaction (HRI '17)*. Association for Computing Machinery, New York, NY, USA, 408. <https://doi.org/10.1145/3029798.3036646>
- [19] E. Repiso, A. Clodic, M. Doering, R. Alami, T. Kanda, D. Brščić, M. Beetz, M. Abdel-Keream, G. Sarthou. *Artificial Intelligence for Social Robots Interacting with Humans in the Real World (intellect4hri)*, 2022 IEEE/RSJ International Conference on Intelligent Robots and Systems (IROS 2022), October 27, 2022.
- [20] Turing, A. M. (1950). Can a machine think. *Mind*, 59(236), 433–460.
- [21] J. R. Kirk, R. E. Wray, P. Lindes, and J. E. Laird, “Evaluating diverse knowledge sources for online one-shot learning of novel tasks,” *arXiv preprint arXiv:2208.09554*, 2022.
- [22] Huang, W., Abbeel, P., Pathak, D., & Mordatch, I. (2022, June). Language models as zero-shot planners: Extracting actionable knowledge for embodied agents. In *International Conference on Machine Learning* (pp. 9118-9147). PMLR.

NEW APPLICATIONS OF RADIO WAVES IN PHYSICAL SENSING



Takuya Kurihara

tkurihara@atr.jp

Takuya Kurihara is a researcher at Advanced Telecommunications Research Institute International. He received his Ph.D. in engineering from the Nippon Institute of Technology, Japan. His research interests include nonlinear systems, signal processing, optimization, and sensors.



Satoru Shimizu

dr.shimizu@atr.jp

Satoru Shimizu is a principal researcher at Advanced Telecommunications Research Institute International. He received his Ph.D. in engineering from the Chiba University, Japan. His research interests include digital signal processing, wireless communication, mechatronics, sensor.

Abstract

The popularity of Cyber-Physical Systems, which aims to optimize real-world information in cyberspace to control physical spaces efficiently, is expected to grow. In order to advance them, improved sensors are necessary to capture real-world information. Although various sensors using various media such as ultrasonic and infrared waves have been developed in the past, research on new sensing methods that utilize radio waves is ongoing. This article introduces our current research on proximity and paper-thin sensors that use radio waves and discusses the future challenges for these sensors.

Introduction

Sensing technology is getting more and more important for automating our societies. Its demand is rising with the growing popularity of

Cyber-Physical Systems (CPS) in various fields such as optimizing factory production lines and public transportation systems.

Sensors come in contact and non-contact types, and the latter has advantage of detecting objects without wearing and tearing on the contact surface, dirt transfer, and fast-moving objects. Different sensor types based on physical phenomena have distinct strengths and weaknesses. For instance, sensors using magnetic forces can only detect metal, while those using light cannot detect transparent objects.

Recently, attention has shifted towards sensing methods using radio waves, which realize new sensing technology. Traditional radio wave sensors include touch sensors that use electrostatic capacitance and distance detectors using radar, which is now also being applied to vital sign detection in recent years. Moreover, the research aims to add sensing capabilities to Wi-Fi devices has

been emerging [1].

Radio waves offer physical properties that enable to measure phenomena that were difficult to be measured by the existing approaches. Compared to the light and laser commonly used in the current sensing technology, radio waves are less affected by color and surface treatments. Furthermore, radio waves can pass through objects, allowing non-destructive detection of internal states. For example, non-contact detection of pressure ulcers within human body is under investigation [2].

Radio waves require antennas to radiate, and their shapes can be flexibly designed such as thin wires or plates on substrates, flexible films, and transparent antennas. Thus, new installation methods are possible.

However, using radio waves for sensing technology has some drawbacks, such as the potential for false detection due to strong electrical noise from nearby devices and unexpected reflections from objects. Nonetheless, selecting an appropriate frequency band with less interference and employing narrow-band filters can reduce interference, and lead to novel sensing technologies.

Our research focuses on detecting instantaneous changes of environment in the vicinity by monitoring antenna impedance, which changes in response to environmental changes. This article introduces our method and its use in proximity and paper-thickness sensors, and discuss future challenges.

Detecting Environmental Changes through Antenna Impedance Monitoring

This method utilizes an oscillator to generate a sine wave fed into an antenna through a feeding line. It measures the complex voltage reflection coefficient of the feeding line when a weak radio wave is emitted into space (see Fig. 1). By monitoring changes in the complex voltage reflection coefficient, the system can detect instantaneous variations of environment in the vicinity. After being radiated into space, the weak radio wave passes through or reflects off objects

around the antenna and returns to the oscillator through the antenna and feeding line. Therefore, the strength and phase of the reflected wave vary depending on the characteristics of the object, and this variation is utilized for sensing.

We can convert the complex voltage reflection coefficient to the antenna impedance if the impedance of the feeding line is known. This method is, therefore, equivalent to measure the antenna impedance.

A sensing circuit based on this method has been designed as shown in Fig. 2. The circuit sets the frequency difference between the feeding frequency and the local oscillator to 5 kHz. The mixer always outputs a signal that is down-converted to 5 kHz, which is then input to the bandpass filter, thereby suppressing interference at frequencies other than the feeding frequency. We are reducing the number of circuit components by implementing IQ conversion in software processing.

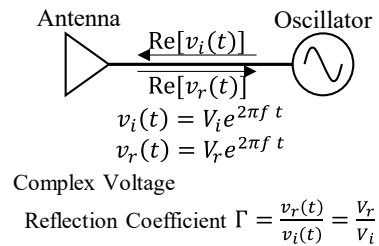

Fig. 1 Sensing Model

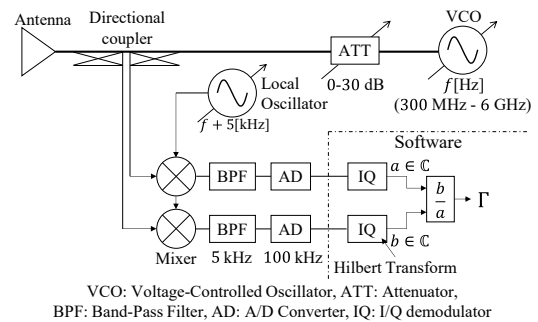

Fig. 2 Block diagram of sensor circuit[4]

Examples of Sensing Applications using Monitoring Antenna Impedance

• Proximity sensor

A proximity sensor detects the presence or movement of an object without physical contact and converts it into an electrical signal. Unlike contact-based sensors, such as limit switches, proximity

sensors do not cause wear and tear on the object or the sensors themselves.

Various proximity sensors include induction, magnetism, electrostatic capacitance, ultrasonic sound wave, infrared wave, and even cameras or radars. For example, active infrared sensors emit near-infrared light and detect its reflection or blocking to detect objects. However, this method cannot detect transparent objects and is susceptible to false detection under sunlight.

Radio wave impedance detection is also applicable to a proximity sensor [3-5]. This method emits weak radio waves from an antenna and detects their reflection by the object being detected. The strength and phase of the reflected waves differ depending on the object's presence, allowing for detection by monitoring the difference from the case when no object is present.

We evaluated this method using a sensor with a microstrip antenna resonating at 2.58 GHz in an anechoic chamber (see Fig. 3). We measured its characteristics using a phantom block that simulated the dielectric constant of the human body. We confirmed that a strong response is obtained when the antenna and the phantom were close to each other, and it can be used as a proximity sensor at distances of a few centimeters (see Fig. 4).

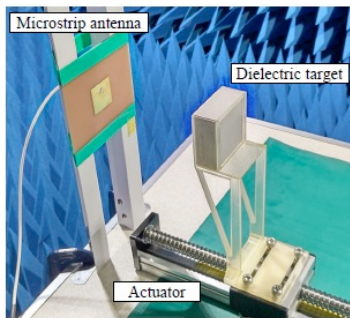

Fig.3 The experimental scene on the proximity sensor. [5]

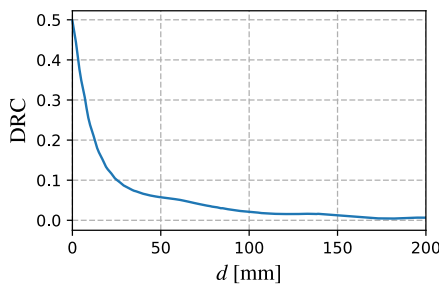

Fig. 4 Detection characteristics with respect to the distance between the antenna and the object (vertical axis: distance of reflection coefficient with and without the object)

• Paper Thickness Sensor

Paper thickness sensor is a non-contact type of sensor commonly used in paper manufacturing, printers, and scanners to detect the thickness of paper. Detecting paper thickness is important to avoid printing failures and scan errors caused by multiple sheets passing through simultaneously. Traditionally, paper thickness was detected by mechanically clamping paper, but this method has wear and tear on the mechanical components and thus leads to a short lifespan of the sensor.

Non-contact methods, such as ultrasonic, optical, and laser methods, have been developed, however they have some limitations such as requiring stationary paper and being affected by its surface properties. We propose using radio waves to detect paper thickness [5-6]. This approach involves creating a gap between an antenna and a metal plate, and measuring the complex voltage reflection coefficient. When paper is inserted into the gap, changes in the complex voltage reflection coefficient caused by the presence or thickness of the paper can be converted into the change of paper thickness measurements (see Fig. 5).



(a) Experimental equipment



(b) Antenna

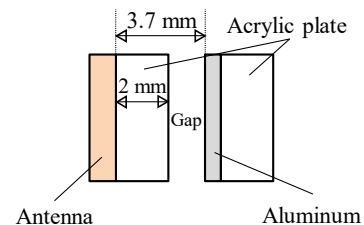

(c) Structure (side)

Fig. 5 Paper Thickness Measurement Equipment

Since radio waves are less affected by surface properties than light, this method is applicable to detect various types and conditions of paper. However, this method may not measure the thickness of paper with ink that contains a large

amount of metal. Fig. 6 plots the complex reflection coefficient for various paper thicknesses when inserted into the gap. This figure shows that the reflection coefficient exhibits different responses depending on the paper thickness, demonstrating that this sensor can detect even small changes in paper thickness.

This radio wave-based method for paper thickness detection is promising due to its non-contact nature and potential to detect various types and conditions of paper. Future research will analyze this method to improve its accuracy and reliability further.

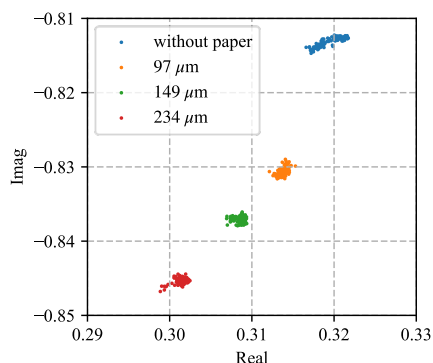

Fig. 6 Characteristics of complex reflection coefficient versus paper thickness

Future Challenges

To further advance and promote the practical applications of this sensing technology, it is essential to analyze its principles and establish a design methodology, as we currently demonstrate its effectiveness through experiments in an anechoic chamber and FDTD analysis. Currently, in this method, suitable shapes of antennas, frequencies of the emitted radio waves, and ambient conditions are needed to be selected by experts according to their application and location. Therefore, we will need further analysis of the principles to allow non-experts to determine suitable configurations for this method.

We will try to expand the scope of our method to emerge new applications. For instance, proximity sensors can expand their scope with distance detection capabilities.

While the principles of the paper thickness sensors have validated, many factors, such as vibration, ambient conditions, and mechanical structure, must be considered to design them for

industrial applications. We strive to overcome these challenges, and develop stable and robust technology.

Acknowledgments

This research and development work was supported by the MIC/SCOPE #JP196000002.

Reference

- [1] S. Tan, Y. Ren, J. Yang and Y. Chen, "Commodity WiFi sensing in ten years: Status challenges and opportunities," *IEEE Internet Things J.*, vol. 9, no. 18, pp. 17832-17843, Sep. 2022. DOI: 10.1109/JIOT.2022.3164569
- [2] M. Kosaka, M. Takahashi, "Stage identification using electromagnetic waves for noncontact bed sores detection system," *Proc. ISAP2019, TA1H-3*, December 2020.
- [3] K. Shintani, S. Shimizu, K. Nagatomo, H. Iwai, S. Ibi, T. Kurihara, T. Sakano, "Distance Detection to a Human Body via a Sensing Technique Based on Changes of Antenna Characteristics" *IEICE Communications Express*, vol.12, no.6, 2023. (in advance publication DOI: 10.1587/comex.2023SPL0002
- [4] T. Kurihara, K. Serizawa, S. Shimizu, T. Sakano, K. Shintani, K. Nagatomo, H. Iwai, S. Ibi, "A Study of Proximity Sensor Circuit Focusing on Variations in Antenna Impedance," *2022 IEEE 33rd Annual International Symposium on Personal, Indoor and Mobile Radio Communications (PIMRC)*, 2022. DOI: 10.1109/PIMRC54779.2022.9977674
- [5] T. Kurihara, K. Serizawa, S. Shimizu, T. Sakano, K. Shintani, K. Nagatomo, H. Iwai, S. Ibi, "Research and Development on New Short-Range Sensing Technology using Radio Waves," *IEICE Tech. Rep.*, vol. 122, no. 401, SRW2022-68, 2023. (in Japanese)
- [6] K. Kubo, K. Shintani, H. Iwai, S. Ibi, T. Kurihara, S. Shimizu, Y. Suzuki, "Detection of paper sheets based on variation of antenna resonance characteristics," *IEICE Communications Express*, vol.10, no.9, pp.625-628, 2021. DOI:10.1587/comex.2021SPL0006
- d J. Wu, "OPTOS: A Strategy of Online Pre-Filtering Task Offloading System in Vehicular Ad Hoc Networks," in *IEEE Access*, vol. 10, pp. 4112-4124, 2022, doi: 10.1109/ACCESS.2022.3141456.